



CATÁLOGO 2024

Maquinaria agrícola



faycom
www.faycom.es

FABRICACIÓN Y COMERCIALIZACIÓN DE SISTEMAS Y
SUS COMPONENTES DE ILUMINACIÓN, SEÑALIZACIÓN
Y SEGURIDAD, PARA TODO TIPO DE VEHICULO DE
SERVICIOS, INDUSTRIALES, AGRÍCOLAS Y
COMERCIALES, RECOGIENDO CADA UNA DE
SUS NECESIDADES.

NOS INSPIRAMOS EN TUS NECESIDADES
PARA ESTABLECER NUESTROS COMPROMISOS

Iluminación

Lighting



Posición delantera, lateral y trasera | Front marker, side marker and tail lights

Blanco delantero | Ámbar lateral | Rojo trasero



Volquetes, cisternas, esparcidores | Application on chassis





Luces de posición de anchura | End outline marker lamps

Blanco delantero | Ámbar lateral | Rojo trasero

LED

12/24 V



FA990208LED

Cable 0,6 m

LED

12/24 V



FA990209LED-I

Izd.

FA990209LED-D

Dch.

Cable 0,3 m

LED

12/24 V



80 x 94 x 83 mm

FA210171LED

Cable 0,5 m

LED

12/24 V



128 x 100 x 47 mm

FA990200LED

Cable 0,5 m

LED

12/24 V



172 x 167 x 47 mm

FA990203LED-I

Izd.

FA990203LED-D

Dch.

Cable 0,5 m

LED

12/24 V



182 x 165 x 47 mm

FA210170LED-I

Izd.

FA210170LED-D

Dch.

Cable 0,5 m



Luces de matrícula | License plate lamps

LED

12/24 V



E/T:50mm
78 x 38 x 38 mm

FA211000

Cable 0,5 m

LED

12/24 V



E/T:40mm
87 x 38 mm

FA210103

Cable 0,5 m

LED

12/24 V



E/T:50mm
90 x 32 x 44 mm

FA210111

Cable 0,5 m

LED

12/36 V



E/T:50mm
83 x 30 x 50 mm

FA210107-A



E/T:50mm
83 x 30 x 50 mm

FA210107LED

Cable 0,5 m

LED

12/36 V



E/T:55mm
83 x 30 x 50 mm

FA211007

Cable 0,25 m

OE PRODUCT

jakon

LED

9/32 V



683 x 133 x 60 mm

FA702123

Con luces de matrículas



▼ Pilotos traseros y delanteros | Front and rear lamps

OE PRODUCT

jakon

LED

12/24 V



IP67 Con cable 225x 105 x 28 mm
100 mm entre tornillos
FA326116 Izd./Dch. 12V

Antiniebla, marcha atrás, posición, freno e intermitente

Glowing

LED

12/24 V



IP69K Con cable 236 x 104 x 28 mm
152 mm entre tornillos
FA326097 Izd./Dch.

Antiniebla, marcha atrás, posición, freno e intermitente

OE PRODUCT

jakon

LED



IP67 Con cable 225 x 105 x 24 mm
100 mm entre tornillos

FA210205 9/16V Izd. Antiniebla

FA210206 9/16V Dch. Marcha atrás

Posición, freno e intermitente

Glowing

LED

10/30 V



IP67 Con cable Intermitente Dinámico 236 x 104 x 40 mm
150 mm entre tornillos

FA326103 Izd. Sin luz matrícula

FA326104 Dch. Sin luz matrícula

Antiniebla, marcha atrás, posición, freno e intermitente

Glowing

LED

12/24 V



IP67 Con cable 228 x 106 x 40 mm
150 mm entre tornillos

FA326105 Izd. Con luz matrícula lateral

Antiniebla, posición, freno e intermitente

FA326106 Dch. Con luz matrícula lateral

Marcha atrás, posición, freno e intermitente

Glowing

LED

12/24 V



IP67 Con cable 220 x 100 x 50 mm
150 mm entre tornillos

FA310100 Izd./Dch. Con luz matrícula lateral

Antiniebla, posición, freno e intermitente

FA310101 Izd./Dch. Con luz matrícula lateral

Marcha atrás, posición, freno e intermitente

Glowing

Intermitente Dinámico

LED

10/30 V



IP67 Con cable 180 x 100 x 37 mm
96 mm entre tornillos

FA326096-I Izd.

FA326096-D Dch.

Posición, freno e intermitente

LED

12/24 V



IP67 Con cable 150 x 80 x 21 mm
100 mm entre tornillos

FA210201 Izd./Dch.

Posición, freno e intermitente

Agrícola

LED

12/24 V



IP67 Con cable 165 x 80 x 35 mm
100 mm entre tornillos

FA326107 Izd. Con luz matrícula lateral

FA326108 Dch. Con luz matrícula lateral

Posición, freno e intermitente

Glowing

LED

12/24 V



IP67 Con cable 165 x 80 x 35 mm
100 mm entre tornillos

FA326109 Izd. Con luz matrícula lateral

FA326110 Dch. Con luz matrícula lateral

Posición, freno e intermitente





Pilotos traseros y delanteros | Front and rear lamps



PRENSAESTOPA

OE PRODUCT



Con catadióptrico

350 x 130 x 83 mm
152 mm entre tornillos

VG152140 Izd. Con luz matrícula

VG152150 Izd./Dch. Sin luz matrícula

VG052500 Izd./Dch. | Tulipa con catadióptrico

VG052000 Izd./Dch. | Tulipa sin catadióptrico



CONECTOR
POSTERIOR



FA501520

OE PRODUCT



Con catadióptrico

350 x 130 x 83 mm
152 mm entre tornillos

VG152170 Izd. Con luz matrícula

VG152180 Izd./Dch. Sin luz matrícula

VG052500 Izd./Dch. | Tulipa con catadióptrico

VG052000 Izd./Dch. | Tulipa sin catadióptrico

OE PRODUCT

jakon



220 x 101 mm
195 mm entre tornillos

FA210198 Izd. Con luz matrícula

FA210199 Dch. Con luz matrícula

Antiniebla, marcha atrás, posición, freno e intermitente

OE PRODUCT

jakon



AGRICOLA Y VARIOS

158 x 64 mm
98 mm entre tornillos

FA210194 Izd. Con luz matrícula

FA210195 Dch. Con luz matrícula



Pilotos traseros y delanteros | Front and rear lamps

UNIVERSAL DELANTERO



85 x 85 x 52 mm
55 mm entre tornillos

FA210196 Izd./Dch.

Posición delantera e intermitente



108 x 103 x 52 mm
55 mm entre tornillos

FA210193-B Izd./Dch.

Posición delantera e intermitente



LED

10/30 V

Con catadióptrico
IP67 105 x 95 x 24 mm
55 mm entre tornillos

FA210207LED Izd./Dch.

Posición delantera e intermitente
Cable 0,25 m

UNIVERSAL TRASERO



LED

12/24 V

Con catadióptrico
IP67

105 x 95 x 40 mm
55 mm entre tornillos

FA210209LED Izd./Dch.

Antiniebla y marcha atrás
Cable 0,25 m



LED

12/24 V

Con catadióptrico
IP67

105 x 95 x 40 mm
55 mm entre tornillos

FA210208LED Izd./Dch. Con luz matrícula

Posición, freno e intermitente
Cable 0,25 m



UNIVERSAL



Con catadióptrico 100 x 100 x 52mm
55 mm entre tornillos
FA210193 Izd./Dch.
Con luz matrícula
Posición, freno e intermitente



LED
12/24 V
Con catadióptrico 100 x 100 x 40 mm
IP67 55 mm entre tornillos
FA210203LED Izd./Dch.
Con luz matrícula
Posición, freno e intermitente
Cable 0,25 m



LED
12 V
Con catadióptrico 100 x 100 x 40 mm
IP67 55 mm entre tornillos
FA210193LED Izd./Dch.
Con luz matrícula
Posición, freno e intermitente
Cable 0,25 m

Glowing



LED
12/24 V
IP67
106 x 99 x 35 mm
45 mm entre tornillos
FA326113 Izd. Con luz matrícula
FA326114 Dch. Con luz matrícula
Posición, freno e intermitente
Cable 0,25 m



LED
12 V
Con catadióptrico 92 x 102 x 26 mm
IP67 45 mm entre tornillos
FA326063 Izd./Dch.
Con luz matrícula
Posición, freno e intermitente
Cable 0,25 m

OE PRODUCT



LED
12 V
Con catadióptrico 92 x 102 x 26 mm
IP67 45 mm entre tornillos
FA326063-C Izd./Dch.
Con luz matrícula y conector DY
(Para instalación Dyrelux)
Posición, freno e intermitente
Cable 0,25 m

Glowing



IP67
FA328001
Kit magnético
Cable 7 m.

LED
12/24 V



FA108101
Kit magnético
Cable 7 m.

Glowing



IP67
FA328002 Placa
1.220 mm
Cable 6 m.

LED
12/24 V



FA328000 Placa
1.000 mm
Cable 4 m.



FA108106 Barra telescópica
1.400 - 2.100 mm
Cable 6 m.





Antiniebla y Marcha atrás | Fog lights, Work and reversing lights |

UNIVERSAL



LED
12/24 V

101 x 81 x 29 mm
65 mm entre tornillos

IP67

FA326112

Antiniebla
Cable 0,5 m



LED
12/24 V

101 x 81 x 29 mm
65 mm entre tornillos

IP67

FA326111

Marcha Atrás
Cable 0,5 m



Con interruptor

IP69K



LED
10/30 V

105 x 105 mm



IP69K

FA503302LED

Faro marcha atrás | Con cable 2 m.



LED
10/30 V

135 x 100 mm

FA503313

Faro de Marcha Atrás y trabajo



Catadióptricos | Reflectors

UNIVERSAL



Tornillo

Ø 60 mm

- **FA101132-A**
- **FA101132-B**
- **FA101132-R**



Adhesivo

Ø 60 mm

- **FA101134-A**
- **FA101134-B**
- **FA101134-R**



Adhesivo

95 x 38 mm

- **FA101137-A**
- **FA101137-B**
- **FA101137-R**



159 x 159 x 159 mm

FA101142



Ø 155 mm

FA101143

Lado triángulo 150 mm

OE PRODUCT

jakon



Ø 90 mm

FA101144



Pilotos redondos | Round tail lamps

UNIVERSAL - 95mm

OE PRODUCT



LED

12/24 V

IP67

Ø95 x 36 mm
45 mm entre tornillos

FA326005-1

Posición, freno e intermitente

FA326005-2

Antiniebla y marcha atrás
Cable 0,3 m

UNIVERSAL - 122 mm

Glowing



LED

12/24 V

IP67

Ø122 x 40 mm
45 mm entre tornillos

FA326002-2

Posición, antiniebla y marcha atrás

FA326002-1

Posición, freno e intermitente
Cable 0,2 m

UNIVERSAL - 140 mm

Glowing



LED

12/24 V

IP67

Ø140 x 41 mm
45 mm entre tornillos

FA326125

Posición, freno e intermitente
Cable 0,3 m

Glowing



LED

12/24 V

IP67

Ø140 x 41 mm
45 mm entre tornillos

FA326127

Posición y antiniebla
Cable 0,3 m

Glowing



LED

12/24 V

IP67

Ø140 x 41 mm
45 mm entre tornillos

FA326126

Posición y marcha atrás
Cable 0,3 m

UNIVERSAL - 140 mm



LED

12/24 V

IP67

Ø140 x 80 mm
45 mm entre tornillos

FA305172

Posición, freno e intermitente



LED

12/24 V

IP67

Ø140 x 80 mm
45 mm entre tornillos

FA305166

Antiniebla



LED

12/24 V

IP67

Ø140 x 80 mm
45 mm entre tornillos

FA305167

Marcha atrás



Ø140 x 80 mm

45 mm entre tornillos

FA305168 Con luz matrícula

FA305169 Sin luz matrícula

Posición, freno e intermitente



Ø140 x 80 mm

45 mm entre tornillos

VGD10839

Antiniebla



Ø140 x 80 mm

45 mm entre tornillos

VGD10840

Marcha atrás





UNIVERSAL

DyreluX



IP69K

FA326032-I Izd.
FA326032-D Dch.

Posición, freno, marcha atrás e intermitente dinámico



FA201563S

Kit conector



FA201563S-25

Conector con cable 2,5 m.

LED

12 V



CONECTOR POSTERIOR



LED

12 V

IP69K

236 x 140 x 25 mm

152 mm entre tornillos

FA326009-I Izd. Con luz matrícula lateral

Antiniebla, posición, freno e intermitente

FA326009-D Dch. Con luz matrícula lateral

Marcha atrás, posición, freno e intermitente



FA201562S

Kit conector



FA201562S-25

Conector con cable 2,5 m.

UNIVERSAL

OE PRODUCT

jakon



IP67

245 x 130 x 22 mm

FA305181-12I Izd.
FA305181-12D Dch.

Antiniebla, marcha atrás, posición, freno e intermitente



FA201561

Kit conector



FA201561-25

Conector con cable 2,5 m.

LED

9/16 V



CONECTOR POSTERIOR



LED

12/24 V

IP67

174 X 218 x 29 mm

150 mm entre tornillos

FA326012-7P Izd.

FA326013-7P Dch.

Antiniebla, marcha atrás, posición, freno e intermitente



FA501520

Kit conector



FA501520-25

Conector con cable 2,5 m.



FA201560

Kit conector



FA201560-25

Conector con cable 2,5 m.

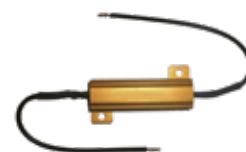

FA356016 12 V

Resistencia



UNIVERSAL

Glowing



LED

12/36 V

IP67

Con cable 0,15m.

245 x 150 x 38 mm

152 mm entre tornillos

FA326139-I Izd. Con luz matrícula

FA326139-D Dch. Con luz matrícula

Antiniebla, marcha atrás, posición, freno e intermitente

Glowing



LED

12/36 V

IP67

Con cable 1 m.

240 x 140 x 55 mm

152 mm entre tornillos

FA326142-I Izd. Con luz matrícula lateral

FA326142-D Dch. Con luz matrícula lateral

Antiniebla, marcha atrás, posición, freno e intermitente

Glowing



LED

12/36 V

IP67

Con cable 1 m.

240 x 140 x 55 mm

152 mm entre tornillos

FA326143-I Izd. Con luz matrícula inferior

FA326143-D Dch. Con luz matrícula inferior

Antiniebla, marcha atrás, posición, freno e intermitente

Glowing



LED

12/36 V

IP67

FA501520

CONECTOR POSTERIOR

240 x 140 x 55 mm

152 mm entre tornillos

FA326144-I Izd. Con luz matrícula inferior

FA326144-D Dch. Con luz matrícula inferior

Antiniebla, marcha atrás, posición, freno e intermitente

LED

12/24 V



IP67

Con cable 2 m.

236 x 140 x 29 mm

152 mm entre tornillos

FA326001-I Izd. Con luz matrícula lateral

Antiniebla, posición, freno e intermitente

FA326001-D Dch. Con luz matrícula lateral

Marcha atrás, posición, freno e intermitente

IP67

Con cable 2 m.

236 x 140 x 25 mm

152 mm entre tornillos

FA326030I Izd. Con luz matrícula lateral

FA326030D Dch. Con luz matrícula lateral

Antiniebla, marcha atrás, posición, freno e intermitente

LED

12 V



LED

12/24 V



IP67

Cable suelto

Con cable 0,3 m

250 x 138 x 30 mm

152 mm entre tornillos

FA326014 Izd.

FA326015 Dch.

Antiniebla, marcha atrás, posición, freno, intermitente y luz de posición lateral

LED

12/24 V



IP67

Conector universal AMP

250 x 138 x 30 mm

152 mm entre tornillos

FA326014-C Izd.

FA326015-C Dch.

Antiniebla, marcha atrás, posición, freno, intermitente y luz de posición lateral





Pilotos traseros LED con triángulo | LED Rear lamps with triangle

UNIVERSAL

Glowing

Intermitente **Dinámico**



LED
10/30 V

Glowing

Intermitente **Dinámico**



LED
10/30 V

Cable suelto

305 x 131 x 60 mm

IP67

FA326047-I Izd. Con luz matrícula

FA326047-D Dch. Con luz matrícula

Antiniebla, marcha atrás, posición, freno e intermitente

Cable suelto

350 x 131 x 60 mm

IP67

FA326048-I Izd. Con luz matrícula

FA326048-D Dch. Con luz matrícula

Antiniebla, marcha atrás, posición, freno e intermitente

LED

12/24 V



Con cable

IP69K

300 x 130 x 40 mm

152 mm entre tornillos

FA326045H Izd.

FA326046H Dch.

CONECTOR POSTERIOR

LED

12/24 V



IP67

385 x 150 x 34 mm

152 mm entre tornillos

FA326011 Izd.

FA326010 Dch.



Pilotos traseros de lámpara con triángulo | Bulb rear lamps with triangle

UNIVERSAL



PRENSAESTOPA



OE PRODUCT



238 x 138 x 52 mm

152 mm entre tornillos

FA305173RB Izd. Con luz matrícula | Antiniebla

FA305174RB Dch. Con luz matrícula | Marcha atrás



CONECTOR POSTERIOR



jakon

OE PRODUCT



200 x 130 x 55 mm

152 mm entre tornillos

FA305183 Izd. Con luz matrícula | Antiniebla

FA305184 Dch. Con luz matrícula | Marcha atrás

FA305257 Izd. | Tulipa

FA305258 Dch. | Tulipa



CONECTOR POSTERIOR



238 x 138 x 52 mm

152 mm entre tornillos

FA326161-I Izd. Con luz matrícula | Antiniebla

FA326161-D Dch. Con luz matrícula | Marcha atrás



FA201562S

Kit conector



FA201563S

Kit conector



FA201562S-25

Conector con cable 2,5 m.



FA201563S-25

Conector con cable 2,5 m.





DyreluX



2450 x 210 x 55 mm

FA702166

Acero blanco(troquelado)



2400 x 230 x 100 mm

FA702035

Aluminio (sin troquelar)



2400 x 230 x 100 mm

FA702165

Acero (troquelado)



580 mm

FA301196

Aluminio

FA301195A

Aluminio negro



FA702163

Juego 2 soportes cuerno



580 mm

FA301197

Aluminio



VGD13725

Guardapolvos



FA702000



FA702005



FA702050



Instalaciones completas

Full installations





KIT REMOLQUE PILOTOS ZEUS 11M

DyreluX

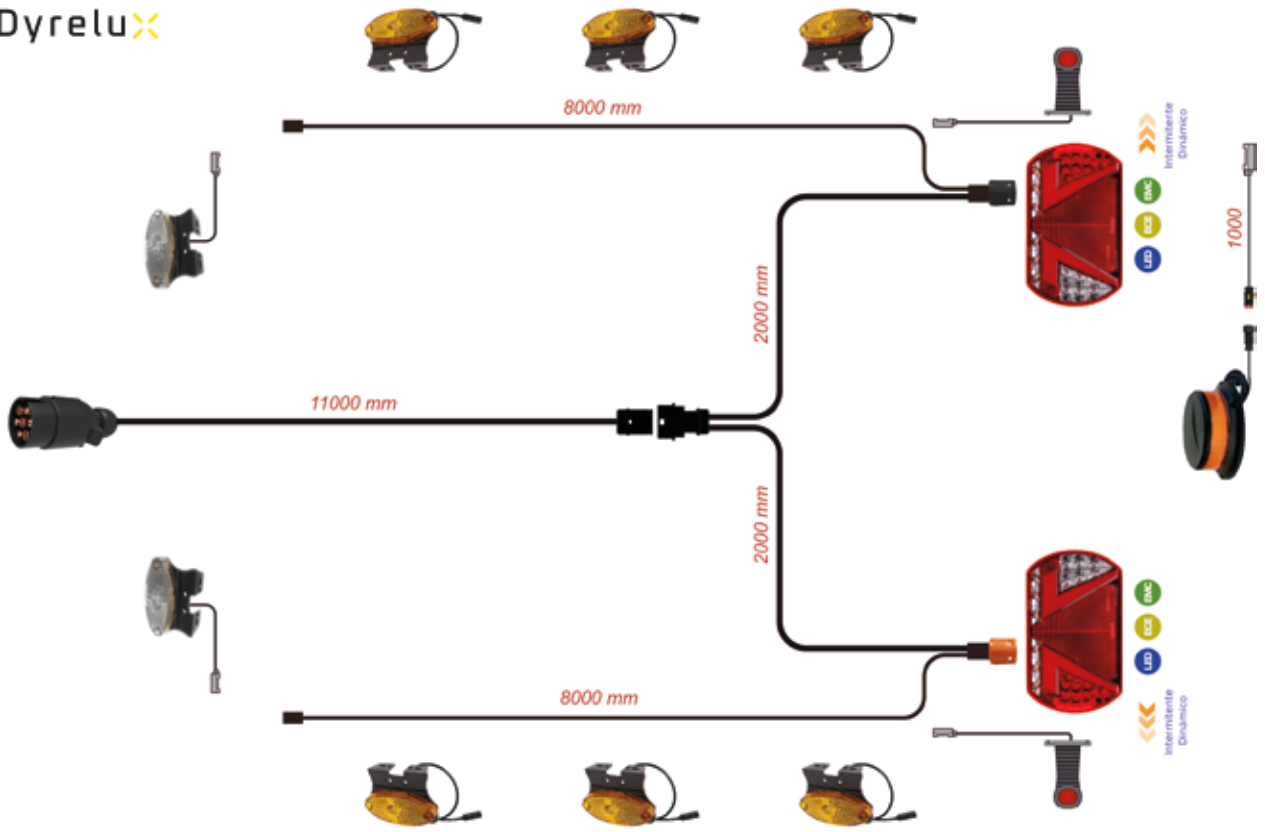

FA328018

KIT REMOLQUE CON TRIÁNGULOS LED 11 METROS

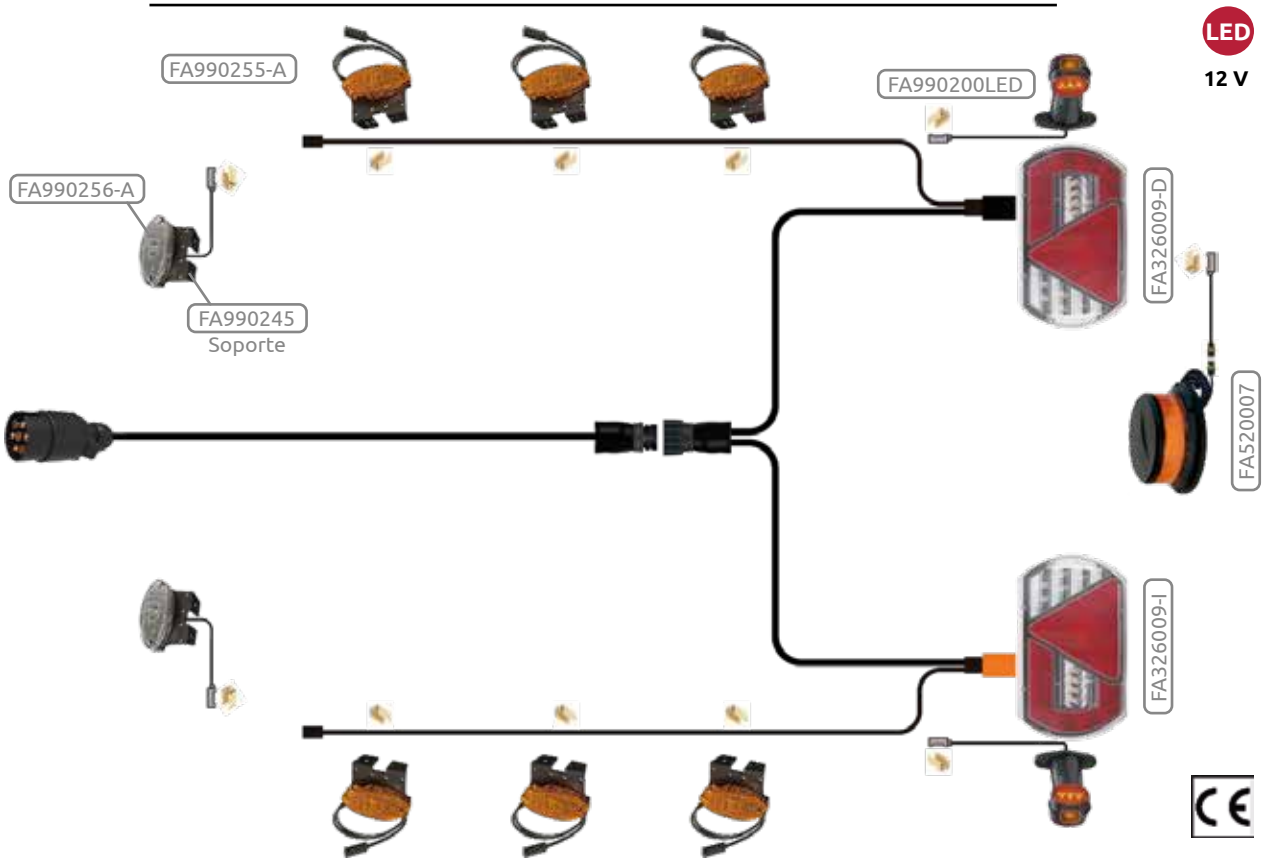

FA328009





KIT ELÉCTRICO EXTENSIBLE

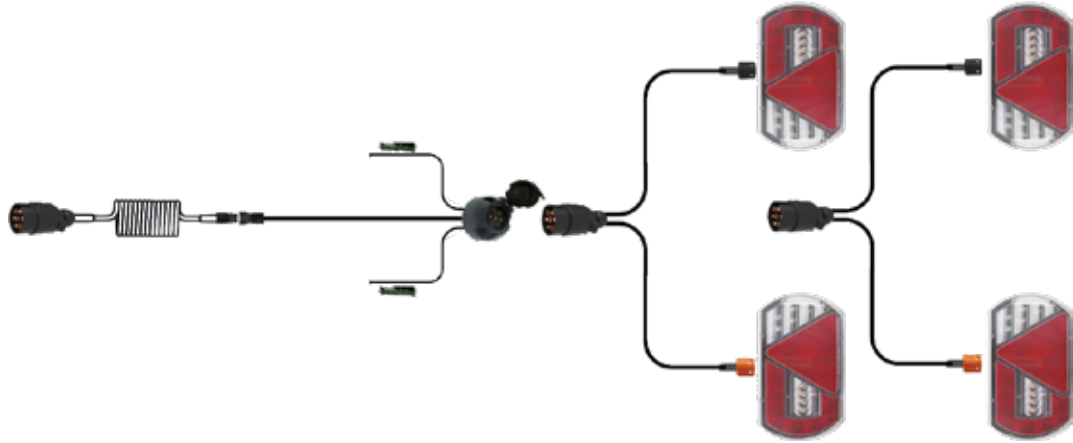

LED
12 V

FA328014

KIT ELÉCTRICO ESPARCIDOR

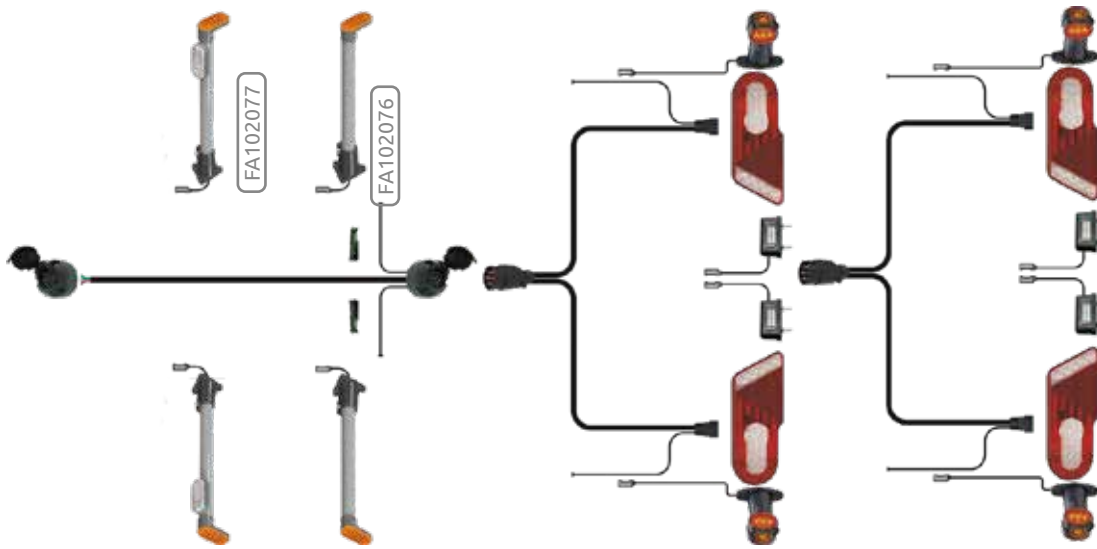

FA328013

KIT REMOLQUE CON PILOTOS DE POSICIÓN DE ANCHURA

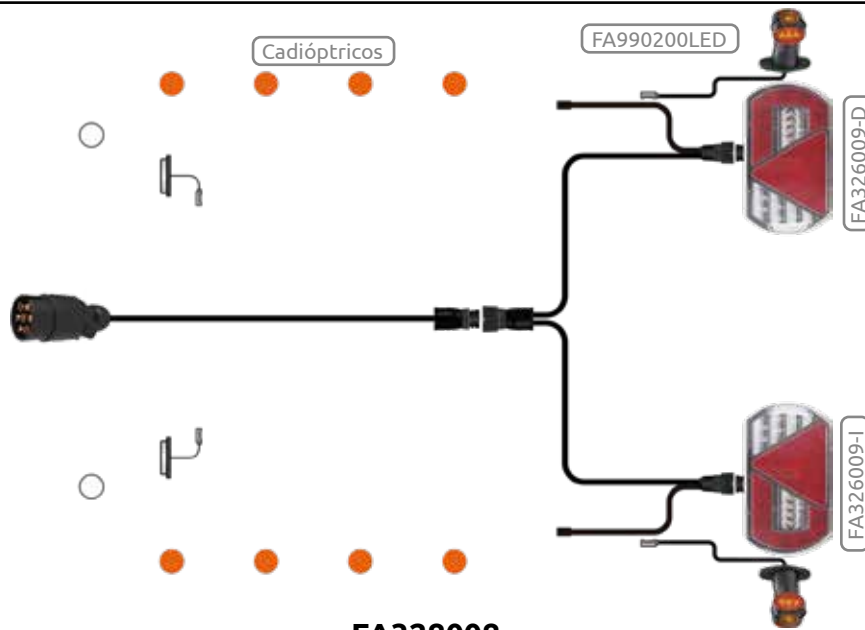

LED
12 V

FA328008



KITS BÁSICOS REMOLQUE CON TRIÁNGULO

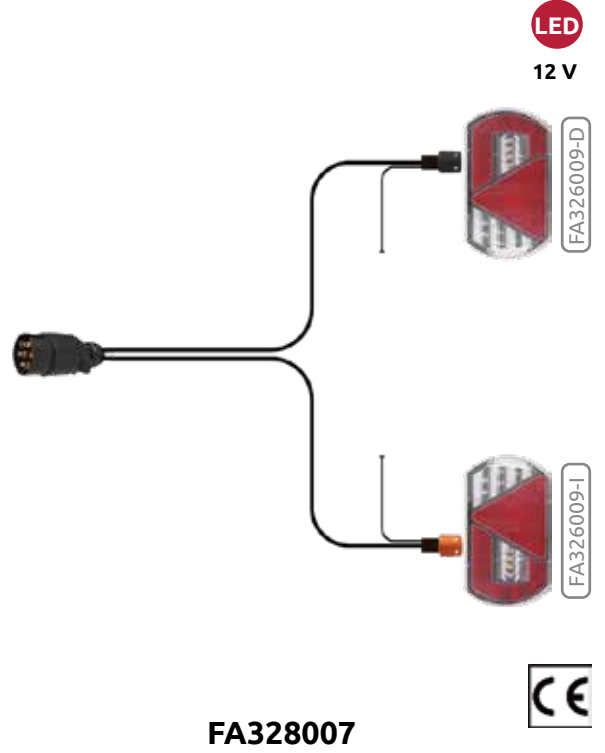
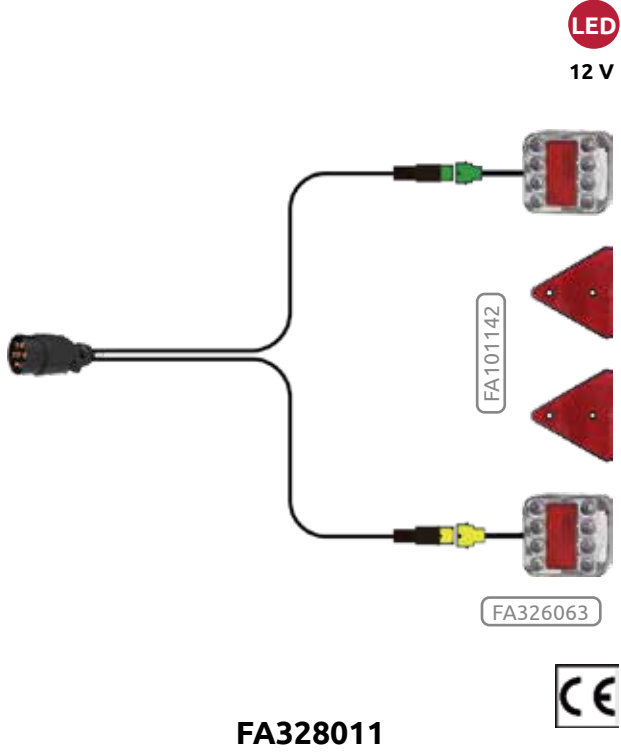

KIT ESTÁNDAR LÁMPARA

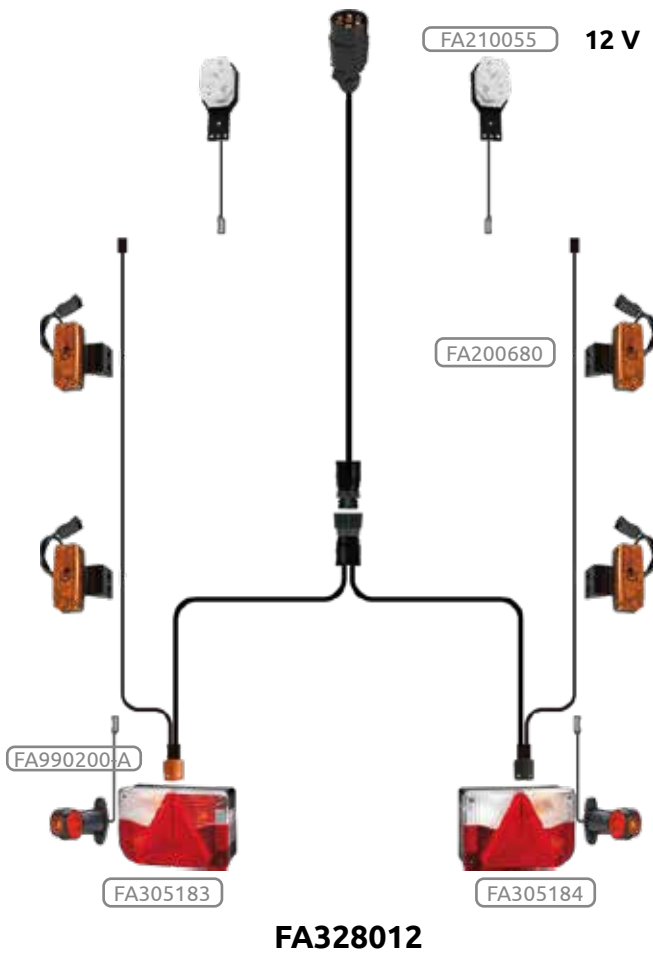

KIT UNIVERSAL CON LÁMPARAS

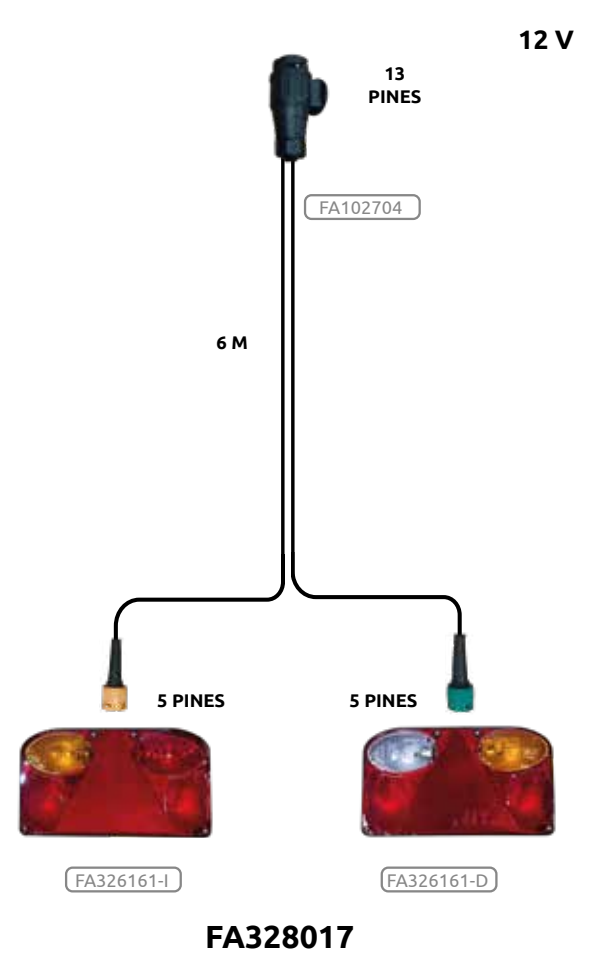

Iluminación especial

Special lighting





Rotativos y destellantes | Flash-Beacons

ILUMINACIÓN ESPECIAL | SPECIAL LIGHTING



LED
12/24 V



LED
12/24 V



LED
12/24 V

Destellante
Con selector 4 secuencias

● **FA101269**

Altura total 82 mm
Ø 140 mm (base)
Magnético con batería recargable
Con zumbador
Con mando inalámbrico

Destellante
Con selector 2 secuencias

● **FA520012**

Altura total 68 mm
Ø 140 mm (base)
Magnético con batería recargable
Con zumbador

1.Rotativo
2.Flash
3.Flash doble
4.Flash cuadruple
Con selector 4 secuencias R65

● **FA101329**

Altura total 82 mm
Ø 140 mm (base)
Base 3 tornillos y magnético | 12W,
12 LED x 1W
Con enchufe mechero



LED
12/24 V



LED
12/24 V



LED
12/24 V

1.Rotativo
2.Flash
3.Flash doble
4.Flash cuadruple
Con selector 4 secuencias R65

● **FA101282LED-R65**

Altura total 136 mm
Ø 140 mm (base)
Base 3 tornillos y magnético | 12W,
12 LED x 1W
Con enchufe mechero

1.Rotativo
2.Flash
3.Flash doble
4.Flash cuadruple
Con selector 4 secuencias R65

● **FA101280LED-R65**

Altura total 122 mm
Ø 140 mm (base)
Base 3 tornillos | 12W, 12 LED x 1W

1.Rotativo
2.Flash
3.Flash doble
4.Flash cuadruple
Con selector 4 secuencias R65

● **FA101281LED-R65**

Altura total 208 mm
Ø 127 mm
Poste DIN | 12W, 12 LED x 1W



LED
12/24 V



LED
12/24 V



LED
12/24 V

1.Rotativo
2.Flash
3.Flash doble
4.Flash cuadruple
Con selector 4 secuencias R65

● **FA101327LED-R65**

Altura total 82 mm
Ø 140 mm (base)
Base 3 tornillos y magnético | 12W,
12 LED x 1W
Con enchufe mechero

1.Rotativo
2.Flash
3.Flash doble
4.Flash cuadruple
Con selector 4 secuencias R65

● **FA101326LED-R65**

Altura total 68 mm
Ø 140 mm (base)
Base 3 tornillos | 12W, 12 LED x 1W

1.Rotativo
2.Flash
3.Flash doble
4.Flash cuadruple
Con selector 4 secuencias R65

● **FA101325LED-R65**

Altura total 153 mm
Ø 115 mm
Poste DIN | 12W, 12 LED x 1W



LED
12/24 V



LED
12/24 V



LED
12/24 V

Destellante
Altura total 117 mm
Ø 85 mm Ø 112 mm (base)

● **FA101242LED-R65**

Magnético | 27W, 18 LED x 1,5W

Destellante
Altura total 70 mm
Ø 85 mm Ø 112 mm (base)

● **FA101240LED-R65**

Base 3 tornillos | 27W, 18 LED x 1,5W

Destellante
Altura total 137 mm
Ø 85 mm

● **FA101241LED-R65**

Poste DIN | 27W, 18 LED x 1,5W





ACCESORIOS PARA ROTATIVOS



FA101129

Soporte con pletina plana



FA101129-T

Soporte de contratuerca



FA101129-G

Soporte orientable



FA101121

Soporte con pletina lateral



FA101122

Soporte con pletina lateral



FA101123

Soporte con pletina plana



FA101131

Soporte extensible hasta 1,3 m.



FA101120

Espiral eléctrica 2 polos

Rotativos, luz trabajo, puentes, estroboscópicas, etc.



FA101120-C

Espiral eléctrica 2 polos

Rotativos, luz trabajo, puentes, estroboscópicas, etc.

Con enchufe mechero



FA681109 12/24 V

Base enchufe clavija

Universal y para rotativos



FA604001 12/24 V

Instalación para iluminación

Con interruptor con 1 salida y relés

Rotativos, luz trabajo, puentes, estroboscópicas, etc.



FA604002 12/24 V

Instalación para iluminación

Con interruptor con 2 salidas y relés

Rotativos, luz trabajo, puentes, estroboscópicas, etc.



Luces estroboscópicas | Strobe lights

ILUMINACIÓN ESPECIAL | SPECIAL LIGHTING

Agrícola



FLEXIBLE



12/24 V

26 secuencias

117 x 27 x 12 mm

● **FA410036**
24W, 6LED x 4W



12/24 V



12/24 V

26 secuencias

110 x 36 x 17 mm

26 secuencias

130 x 54 x 17 mm

● **FA410010A**
20W, 4 LED x 5W

● **FA410013A**
60W, 12 LED x 5W



12/24 V



12/24 V

26 secuencias

130 x 36 x 17 mm

26 secuencias

106 x 30 x 34 mm

● **FA410012A**
30W, 6 LED x 5W

● **FA410005**
9W, 3 LED x 3W



9/30 V



9/30 V

26 secuencias

80 x 19 x 28 mm

26 secuencias

128 x 19 x 28 mm

● **FA101442**
9W, 3 LED x 3W

● **FA101448**
18W, 6 LED x 3W

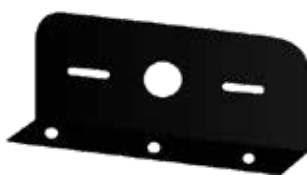

FA410001
Soporte corto

115 x 63 x 20 mm



FA410002
Soporte largo

142 x 63 x 20 mm





Minipuentes luminosos | Minibars



IP67



9/30 V



Con selector 13 secuencias

● **FA101456**

382 x 221 x 46 mm

Tornillos y magnético | 56W, 56 LED x1W
Con interruptor y selector en enchufe mechero



IP67



12/24 V



Con selector 26 secuencias

● **FA520000A**

595 x 305 x 123 mm

Tornillos y magnético | 168W, 56 LED x 3W
Con interruptor y selector en enchufe mechero



IP67



12/24 V



Con selector 3 secuencias

● **FA520001A**

409 x 200 x 88 mm

Tornillos y magnético | 72W, 24 LED x 3W
Con interruptor en enchufe mechero



IP67



12/80 V



● **FA101497**

394 x 135 x 220 mm

Tornillo | 168W, 168 LED x 1W



IP67



12/80 V



● **FA101498**

394 x 153 x 220 mm

Magnético | 168W, 168 LED x 1W
Con interruptor en enchufe mechero



IP67



12/24 V



Con selector 26 secuencias

● **FA520002A**

180 x 200 x 40 mm

Magnético | 32W, 32 LED x 1W
Con interruptor en enchufe mechero





Faros de trabajo | Worklights

ILUMINACIÓN ESPECIAL | SPECIAL LIGHTING

Agrícola



LASER

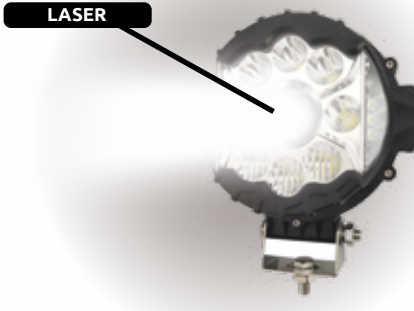

9/32 V

IP69K

176 x 185 x 74 mm

FA503170

Faro de trabajo LED con haz de luz laser
7.800 lumens | 48W Leds + 40W Laser



10/30 V



10/30 V

IP67

FA503203LED-A

3.500 lumens | 48W, 16 LED x 3W

108 x 108 x 65 mm

IP67

FA503203LED-B

3.500 lumens | 48W, 16 LED x 3W

108 x 108 x 65 mm



10/30 V



10/36 V

IP67

FA503206LED-A

2.200 lumens | 27W, 9 LED x 3W

Ø115 x 55 mm

IP67

FA503184

2.000 lumens | 24W, 8 LED x 3W

142 x 88 x 65 mm



10/80 V



10/80 V

Carretillas y varios

IP67

FA503178

Faro de trabajo
7.200 lumens | 72W, 24 LED x 3W

155 x 110 x 60 mm

IP67

Con interruptor
Carretillas y varios

FA503187

Faro de trabajo
2.880 lumens | 26W, 26LED x 1W

125 x 95 x 50 mm

FA201566



10/30 V



10/30 V

IP67

FA503196

Faro de trabajo
1.200 lumens | 12W, 20 LED

99 x 91 x 65 mm

IP67

FA503197

Faro de trabajo
1.800 lumens | 18W, 30 LED

133 x 91 x 65 mm





- **FA511021-A**
120W, 40 LED x 3W



IP67

546 x 55 x 77 mm

LED

9/32 V

- **FA511022-A**
180W, 60 LED x 3W



IP67

800 x 55 x 77 mm

LED

9/32 V

- **FA511023-A**
288W, 96 LED x 3W



IP67

1260 x 55 x 77 mm

LED

9/32 V

- **FA511024-A**
120W, 40 LED x 3W
Curvo



IP67

554 x 55 x 77 mm

LED

9/32 V

- **FA511025-A**
240W, 80 LED x 3W
Curvo



IP67

1068 x 55 x 77 mm

LED

9/32 V



CONSULTA GAMA COMPLETA DE INTERRUPTORES DE CONTROL EN LA PÁGINA 37



ILUMINACIÓN AGRÍCOLA Y OBRAS PÚBLICAS



IP67

Kit 2 faros, izquierdo y derecho, con posición, intermitente delantero y trasero, luces cortas y largo alcance



Posición, intermitente delantero y lateral, luces cortas y largo alcance



Posición, intermitente delantero y lateral, luces cortas y largo alcance



Posición, intermitente delantero y trasero, luces cortas y largo alcance

OEM A0831A673200



Posición, intermitente delantero y trasero, luces cortas y largo alcance

OEM A0831A673300



FA802022
Resistencia para
FA802020, FA802021, FA802014 y FA802015



ILUMINACIÓN AGRÍCOLA, OBRAS PÚBLICAS Y CARRETIILLAS



10/30 V

Halo posición

IP67

151 x 172 x 126 mm

○ FA802016

Luces cortas y largo alcance



12 V



12 V

IP69K

240 x 164 x 127 mm

IP69K

240 x 164 x 127 mm

FA802010 ◀ I H4 21W 5W

OEM A0830A673600

Posición, intermitente delantero y trasero, luces cortas y largo alcance

FA802011 ▶ I H4 21W 5W

OEM A0830A673700

Posición, intermitente delantero y trasero, luces cortas y largo alcance



24 V



24 V

IP69K

240 x 164 x 127 mm

IP69K

240 x 164 x 127 mm

FA802012 ◀ I H4 21W 5W

OEM A0830A673400

Posición, intermitente delantero y trasero, luces cortas y largo alcance

FA802013 ▶ I H4 21W 5W

OEM A0830A673500

Posición, intermitente delantero y trasero, luces cortas y largo alcance



Carretilas y varios

Cable con conector

Soporte Ajustable



10/80 V

IP69K

118 x 194 x 72 mm

FA802123 ◀ I LED

Posición, intermitente y luces cortas

FA802124 ▶ I LED

Posición, intermitente y luces cortas



Luces interiores | Interior lights



LED
12/24 V



IP67

Ø 155 x 14 mm

IP67

FA210408

700 lumens | 21 LED (SMD)

Con sensor infrarrojo de movimiento (PIR)

LED
12/24 V



IP67

Ø 155 x 16 mm

FA210400

420 lumens | 21 LED (SMD)

LED
12/24 V



IP67

Ø 177 x 16 mm

FA210401

780 lumens | 39 LED (SMD)



Ø 155 mm

FA210402

Aro embellecedor



Ø 155 mm

FA210143

Aro para empotrar



Ø 177 mm

FA210403

Aro embellecedor

Avisadores acústicos de marcha atrás | Reversing alarms



IP67

102 x 68 x 36 mm

FA220201 12/24 V

Doble sonido 82-107 dB



IP67

102 x 68 x 36 mm

FA220206 12/80 V

Doble sonido 82-107 dB



IP67

102 x 89 x 43 mm

FA220204 9/80 V

82-102 dB | Con luz indicadora estroboscópica



IP67

102 x 89 x 43 mm

FA220205 9/80 V Sonido ronco

87-107 dB | Con luz indicadora estroboscópica



Retrovisión inteligente

Intelligent rearview



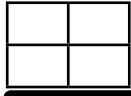

Homologado



FA511037 Monitor 185 x 122 x 25 mm
10/32 V

- Kit monitor con cámara
- Sistema inalámbrico (Wireless)
- Monitor color 7" HD Alta Resolución
- Cámara HD a color
- Cámara visión nocturna 18 LED
- Grabación a tiempo real en tarjeta micro SD de 128Gb (no incluida)

Posibilidad de conectar hasta 4 cámaras

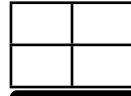

Homologado



FA511041 Monitor 192 x 129 x 27 mm
10/32 V

- Kit monitor con cámara
- Sistema inalámbrico (Wireless)
- Monitor color 9" HD Alta Resolución
- Cámara HD a color con micrófono
- Cámara visión nocturna 18 LED
- Grabación a tiempo real en tarjeta micro SD de 128Gb (no incluida)

Posibilidad de conectar hasta 4 cámaras



Homologado



FA511038 12/36 V

- Kit especial carretillas monitor con cámara
- Sujeción por tornillos e imantado
- Sistema inalámbrico (Wireless)
- Recomendado para su uso con batería

Posibilidad de conectar hasta 2 cámaras



FA511053 12 V

Batería recargable para cámaras

Compatible entre todos nuestros monitores inalámbricos

Compatible entre todos nuestros monitores inalámbricos

Homologado

IP69K



FA511040 Cámara 90 x 80 x 78 mm
10/24 V

- Cámara HD a color
- Ángulo visión 135°
- Visión nocturna 18 LED

IP67



FA511047 12/24 V

- Cámara HD a color
- Con luz
- Especial carretilla elevadora
- Sujeción por tornillos e imantado



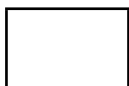

Homologado



FA511043 10/32 V

- Kit monitor con cámara y cableado 20 m.
 - Monitor color 7" HD Alta Resolución
 - Cámara HD a color
 - Cámara visión nocturna 18 LED
- Posibilidad de conectar hasta 2 cámaras

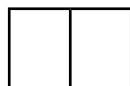

Homologado



FA511044 10/32 V

- Kit monitor con cámara y cableado 20 m.
 - Monitor color 7" HD Alta Resolución
 - Pantalla divisible (Hasta 2 cámaras)
 - Cámara HD a color con micrófono
 - Cámara visión nocturna 18 LED
 - Grabación a tiempo real en tarjeta micro SD (no incluida)
- Posibilidad de conectar hasta 2 cámaras

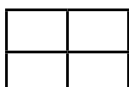

Homologado



FA511045 10/32 V

- Kit monitor con cámara y cableado 20 m.
 - Monitor color 9" HD Alta Resolución
 - Pantalla divisible (Hasta 4 cámaras)
 - Cámara HD a color con micrófono
 - Cámara visión nocturna 18 LED
 - Grabación a tiempo real en tarjeta micro SD (no incluida)
- Posibilidad de conectar hasta 4 cámaras



FA511054 12/24 V

Kit transformación de cámara con cable a inalámbrica.

Compatible entre nuestros monitores con cable

Compatible entre nuestros monitores con cable

IP69K



FA511048 12/24 V

- Cámara HD a color
- Con luz de trabajo (Blanco y Ámbar)
- Ángulo visión 120°

Homologado
IP69K



FA511046

- Cámara HD a color
- Ángulo visión 135°
- Visión nocturna 18 LED
- Con micrófono

Cable adicional compatible entre nuestras cámaras con cable



FA511012

Cable cámara adicional 10 m.



FA511010

Cable cámara adicional 20 m.



FA511055

Kit instalación cámaras retrovisión, para plataforma y remolques. Hasta 2 cámaras.



FA511056

Kit instalación cámaras retrovisión, para plataforma y remolques. Hasta 4 cámaras.



FA511012

Cable cámara adicional 10 m.



FA511010

Cable cámara adicional 20 m.



FA511054 12/24 V

Kit transformación de cámara con cable a inalámbrica.



FA511053 12V

Batería recargable para cámaras



Componentes eléctricos

Electric components





MANDOS CON SUJECCIÓN MAGNÉTICA



FA400004

Universal | 2 pulsadores



FA400014

Con espiral y Clavija | 2 pulsadores



FA400005

Universal | 3 pulsadores



FA400015

Con espiral y Clavija | 3 pulsadores



FA400006

Universal | 4 pulsadores



FA400016

Con espiral y Clavija | 4 pulsadores





MANDOS CON BOTÓN PARO EMERGENCIA



FA400007

Universal | 2 pulsadores



FA400017

Con espiral y Clavija | 2 pulsadores



FA400008

Universal | 4 pulsadores



FA400018

Con espiral y Clavija | 4 pulsadores

ACCESORIOS



Ø 40 mm

FA101000-0A

Espiral con Clavija
7 polos Tipo N (ISO 1724)



Ø 40 mm

FA101000-0 Espiral

6 x 1 mm² + 1 x 1,5 mm²



FA200600 12 V

Clavija de aluminio
7 polos Tipo N (ISO 1724)



COMPONENTES Y CABLEADOS UNIVERSALES



FA680400 6/24 V
Clavija 2 polos



FA680400JA 6/24 V
Clavija 2 polos
Con adaptador



FA681100 12/24 V
Base 2 polos



FA681109 12/24 V
Base enchufe clavija
Universal y para rotativos



FA680000 12/24 V
Adaptador 2 USB carga rápida



FA682500
Interruptor simple



FA682501
Interruptor simple



FA101120
Espiral eléctrica 2 polos
Rotativos, luz trabajo, puentes, estroboscópicas, etc.



FA101120-C
Espiral eléctrica 2 polos
Rotativos, luz trabajo, puentes, estroboscópicas, etc.
Con enchufe mechero



12/24 V

FA604001
Instalación para iluminación
Con interruptor con 1 salida y relés
Rotativos, luz trabajo, puentes, estroboscópicas, etc.



12/24 V

FA604002
Instalación para iluminación
Con interruptor con 2 salidas y relés
Rotativos, luz trabajo, puentes, estroboscópicas, etc.





SISTEMA PARA MONTAJE PERSONALIZADO



FA681111 12/24 V
Base enchufe clavija
Universal y para rotativos



FA681112 12/24 V
Adaptador 2 USB



FA681113
Interruptor 1 posición



FA681114 12/24 V
Kit base mechero y cargador USB

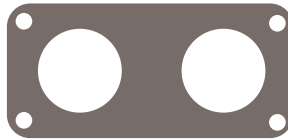

FA683000
Placa soporte

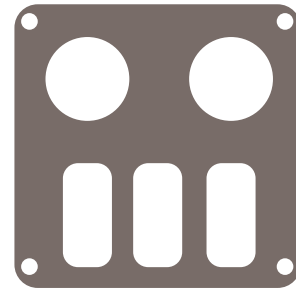

FA683003
Placa soporte



FA682000
Interruptor 1 posición



FA682001
Interruptor 1 posición



FA682002
Interruptor 2 posiciones



FA683001
Placa soporte



FA683002
Placa soporte



SISTEMA DE CONTROL ELÉCTRICO CON MANDO A DISTANCIA



FA105207

Sistema de control con mando a distancia y bluetooth para accesorios electricos (Faros, puentes luminosos, luces trabajo, etc.). Con 6 salidas independientes (Puertos de 10A y 20A max.) Potencia maxima por puerto de 250W. Potencia total 600W.

SISTEMA DE CONTROL ALTAVOZ/SIRENA, PUENTES, LUCES DE TRABAJO Y VARIOS



FA520055 12V

Sistema de control Altavoz/Sirena, puente y luces trabajo



FA520056 24V

Sistema de control Altavoz/Sirena, puente y luces trabajo



110hm
150W
IP56
115dB

FA520057 12V/24V

Altavoz/Sirena Universal independiente





JNC770R-EU



ARRANCADOR 12 V

- Cargador automático 3 A (carga más rápida) y regulación en función de necesidad
- Pinzas industriales extra resistentes 1000A de intensidad
- Cable extra largo de 1,75 m. de amplia sección con alto aporte de amperaje
- Interruptor/Desconector ON/OFF
- 2 Puertos USB de alimentación 1.1A y 2.1A
- Luz de trabajo LED de alta intensidad
- Carcasa de plástico ultraresistente
- Servicio técnico de arrancadores

JNC1224



ARRANCADOR 12/24 V

- Voltaje 12/24 V
- 3600/1800 Amperios Pico
- Capacidad batería 2 x 22 AH
- Cargador automático
- Cable de 1,17 metros.
- Selector 12/24 V con asa para selección de voltaje.
- Cables HEAVY DUTY de arranque, largos y resistentes, que permanecen flexibles a temperaturas externas.
- Pinzas industriales sólidas con dientes de cobre estañado.
- Salida 12V para dar energía a accesorios, con una protección de circuitos para protegerse de sobrecargas.
- Servicio técnico de arrancadores



Faycom proporciona garantía y servicio técnico de reparación para todos nuestros arrancadores.



JNC325



ARRANCADOR 12 V

- Arrancador 12 V
- 450 Amperios arranque
- Capacidad batería 14,8V/74Wh
- Cargador automático
- Cable de 0,5 metros.
- Incluye estuche de almacenamiento
- 2 salidas USB
- Pinzas inteligentes sólidas.
- Incluye accesorios para su carga.
- Cables de arranque de cobre, industriales, resistentes al frío -32°C, al aceite, el gas y carburante.
- Carga con panel LED que informan del estado de la carga.
- Servicio técnico de arrancadores.

C-4001



ARRANCADOR 12/24 V

- Voltaje 12/24 V
- Cargador automático de 7 Amperios
- Capacidad de la batería 2 x 65 AH
- Pinzas industriales extra resistentes
- Cables extra largos de 3 metros de 50 mm²
- Ruedas neumáticas profesionales
- Potencia de entrada (Cargador) 120-240 VAC, 50-60 Hz
- Temporizador e interruptor/desconectador ON/OFF
- Pantalla con luz LED más Voltímetro digital
- Protección contra sobrecargas
- Protección de polaridad inversa automática
- Servicio técnico de arrancadores



Faycom proporciona garantía y servicio técnico de reparación para todos nuestros arrancadores.



Cableados y conectores

Wiring and connectors





CABLE UNIPOLAR



Indicar color deseado

FA2000X0,75	1 x 0,75 mm ²	Rollo de 100 m.
FA2000X1	1 x 1 mm ²	Rollo de 100 m.
FA2000X1,5	1 x 1,5 mm ²	Rollo de 100 m.
FA2000X2,5	1 x 2,5 mm ²	Rollo de 100 m.
FA2000X4	1 x 4 mm ²	Rollo de 100 m.
FA2000X6	1 x 6 mm ²	Rollo de 100 m.
FA2000X10	1 x 10 mm ²	Rollo de 50 m.
FA2000X16	1 x 16 mm ²	Rollo de 50 m.

CABLE DE ARRANQUE



Rollo de 25 m.



Rollo de 25 m.

FA2000X25	25 mm ²
FA2000X35	35 mm ²
FA2000X50	50 mm ²
FA2000X70	70 mm ²

FA2000X35R	35 mm ²
FA2000X50R	50 mm ²
FA2000X70R	70 mm ²

MANGUERA PARA INSTALACIONES



Rollo de 100 m.

FA2002X1	2 x 1 mm ²
FA2002X1,5	2 x 1,5 mm ²
FA2002X2,5	2 x 2,5 mm ²
FA2003X1	3 x 1 mm ²
FA2003X1,5	3 x 1,5 mm ²
FA2003X2,5	3 x 2,5 mm ²

FA2004X1	4 x 1 mm ²
FA2004X1,5	4 x 1,5 mm ²
FA2004X6	4 x 6 mm ²
FA2005X1	5 x 1 mm ²
FA2006X1	6 x 1 mm ²
FA2006X1,5	6 x 1,5 mm ²





ESPECIAL 12V



FA101010-L Corta
Espiral + Manguera 2,5 m.

FA101011-L Larga
Espiral + Manguera 6,2 m.



FA101012-A Corta
Espiral + Manguera 2,5 m.

FA101013-A Larga
Espiral + Manguera 6,2 m.



FA101012-2A Corta
Espiral + Manguera 2,5 m.

FA101013-2A Larga
Espiral + Manguera 6,2 m.



FA101000-0A Ø 40 mm
Espiral con 1 clavija
7 polos (ISO 1724)



FA101040 12 V Ø 40 mm
Espiral con clavija y base aérea
7 polos (ISO 1724)



FA101022-A Ø 40 mm
Espiral con 2 clavijas
12V Aluminio | (ISO 1724)



FA101022-B Ø 40 mm
Alternativa a FA101022-A
12V Aluminio | (ISO 1724)



FA101022-P Ø 40 mm
Espiral con 2 clavijas
12V Plástico | (ISO 1724)

ADAPTACIONES ESPECIALES



FA101023-A Ø 40 mm
Espiral con 2 clavijas
Tipo N | (ISO 1185) 12V | (ISO 1724)



FA101025-A Ø 40 mm
Espiral con 2 clavijas
24 V | (ISO 1185) 4 polos

ESPECIAL UNIVERSALES



FA101000-0 Ø 40 mm
6 x 1 mm² + 1 x 1,5 mm²



FA101002 Ø 90 mm
6 x 1,5 mm² + 1 x 2,5 mm²
Longitud de trabajo 6 m.



FA101004 Ø 90 mm
4 x 6 mm²



2 POLOS



FA680400 6/24 V
Clavija 2 polos



FA680400JA 6/24 V
Clavija 2 polos
Con adaptador



FA681100 12/24 V
Base 2 polos



FA681109 12/24 V
Base enchufe clavija
Universal y para rotativos



FA200620 6/42 V
Clavija 2 polos | (DIN 14690)



FA200623 6/42 V
Base 2 polos | (DIN 14690)

3 POLOS



FA200621 6/24 V
Clavija 3 polos



FA200624 6/24 V
Base 3 polos

3 POLOS (DIN 9680)



FA681800 12/24 V
Clavija 3 polos



FA681800-B 12/24 V
Alternativa a FA681800



FA681700 12/24 V
Base 3 polos



FA681700-B 12/24 V
Alternativa a FA681700





4 POLOS



FA200622 6/24 V
Clavija 4 polos | (DIN 72575)



FA200625 6/24 V
Base 4 polos | (DIN 72575)

ISOBUS (ISO 11783-2) 9 POLOS



FA200730 12 V
Clavija 9 polos | Sistema Isobus



FA200735 12 V
Conector 4 polos | Sistema Isobus



ACTIVA



FA200731 12 V
Base 9 polos | Sistema Isobus | Activa



PASIVA



FA200732 12 V
Base 9 polos | Sistema Isobus | Pasiva

ABS-EBS (ISO 7638-2) 12V



12V
ISO7638-2



FA200733
Clavija EBS/ABS 12V 7 pines hembra
Agrícola y Varios



12V
ISO7638-2



FA200734
Base EBS/ABS 12V 7 pines macho
Agrícola y Varios



7 POLOS TIPO N (ISO 1724) 12 V



FA200600 12 V

Clavija de aluminio | 7 polos Tipo N (ISO 1724)



FA200600-B 12 V

Alternativa a FA200600 | 7 polos Tipo N (ISO 1724)



FA200600-P 12 V

Clavija de plástico | 7 polos Tipo N (ISO 1724)



FA200600-PB 12 V

Alternativa a FA200600-P | 7 polos Tipo N (ISO 1724)



FA200612 12 V

Base de aluminio | 7 polos Tipo N (ISO 1724)



FA200612-B 12 V

Alternativa a FA20012 | 7 polos Tipo N (ISO 1724)



FA200612-P 12 V

Base de plástico | 7 polos Tipo N (ISO 1724)



FA200612-PB 12 V

Alternativa a FA200612-P | 7 polos Tipo N (ISO 1724)



FA549700 12 V

Base aérea | 7 polos Tipo N (ISO 1724)



Ø 40 mm

FA101040 12 V

Espiral con clavija y base aérea
7 polos (ISO 1724)





13 POLOS (ISO 11446) 12 V



FA200728 12 V

Clavija de plástico | 13 polos (ISO 11446)



FA200709 12 V

Base de plástico | 13 polos (ISO 11446)



7 polos

13 polos

FA200715 Adaptador 12 V

Clavija 7 polos Tipo N (ISO 1724)
a base 13 polos (ISO 11446)



7 polos

13 polos

FA200714 Adaptador alternativo 12 V

Clavija 7 polos Tipo N (ISO 1724)
a base 13 polos (ISO 11446)



13 polos

7 polos

FA200718 Adaptador compacto 12 V

Clavija 13 polos (ISO 11446)
a base 7 polos Tipo N (ISO 1724)



FA200708 12 V

Base aérea | 13 polos (ISO 11446)

KIT ELÉCTRICO DE COMPATIBILIDAD UNIVERSAL PARA REMOLQUES



FA610001 12 V

7 polos Tipo N (ISO 1724)



2 VÍAS



DT **FA201566**
Kit Conector 2 vías DT
Conector macho, pins hembra
Sección 0,5/1,5 mm²



DT **FA201566-5**
2 vías 0,5 m.
FA201566-15
2 vías 1,5 m.



DT **FA201565**
Kit Conector 2 vías DT
Conector hembra, pins Macho
Sección 0,5/1,5 mm²



DT **FA201565-5**
2 vías 0,5 m.
FA201565-15
2 vías 1,5 m.



DYRELUX **FA201515**
Kit Conector de 2 a 7 vías
Conector macho, pins hembra



DYRELUX **FA201515-5**
2 vías 0,5 m.
FA201515-15
2 vías 1,5 m.



DYRELUX **FA201510**
Kit Conector de 2 a 7 vías
Conector hembra, pins macho



DYRELUX **FA201510-5**
2 vías 0,5 m.
FA201510-15
2 vías 1,5 m.

4 VÍAS



DT **FA201568**
Kit Conector de 4 vías DT
Conector macho, pins hembra



DT **FA201568-5**
4 vías 0,5 m.
FA201568-15
4 vías 1,5 m.
FA201568-85
4 vías 8,5 m.



DT **FA201567**
Kit Conector de 4 vías DT
Conector hembra, pins Macho



DT **FA201567-5**
4 vías 0,5 m.
FA201567-15
4 vías 1,5 m.

5 VÍAS



FA201562S Izd.
Kit Conector de 5 vías
Conector macho, pins hembra



FA201562S-25 Izd.
Conector 5vías
Con cable 2,5 m.



FA201563S Dch.
Kit Conector de 5 vías
Conector macho, pins hembra



FA201563S-25 Dch.
Conector 6 vías
Con cable 2,5 m.





6 VÍAS



JOKON

FA201560

Izd.
Kit Conector de 6 vías
Conector macho, pins
hembra



JOKON

FA201560-25

Izd.
Conector 6 vías
Con cable 2,5 m.



JOKON

FA201561

Dch.
Kit Conector de 6 vías
Conector macho, pins
hembra



JOKON

FA201561-25

Dch.
Conector 6 vías
Con cable 2,5 m.



DT

FA201570

Kit Conector de 6 vías DT
Conector macho, pins
hembra



DT

FA201570-5

6 vías 0,5 m.

FA201570-15

6 vías 1,5 m.



DT

FA201569

Kit Conector de 6 vías DT
Conector hembra, pins
macho



DT

FA201569-5

6 vías 0,5 m.

FA201569-15

6 vías 1,5 m.

7 VÍAS



AMP 1,5

FA501520

Kit Conector de 7 vías
Conector macho, pins hembra



AMP 1,5

FA501520-25

Conector 7 vías
Con cable 2,5 m.

ALARGADORES CONEXIÓN



Pilotos
A.M.P. 1,5

Instalación
A.M.P. 1,5

FA200864

Adaptador 2 pilotos 0,50m



Piloto
A.M.P. 1,5

Instalación
A.M.P. 1,5

FA200871-15

Prolongador 1,5m

FA200871-25

Prolongador 2,5m



INSTALACIONES AGRICOLA Y REMOLQUE 12V

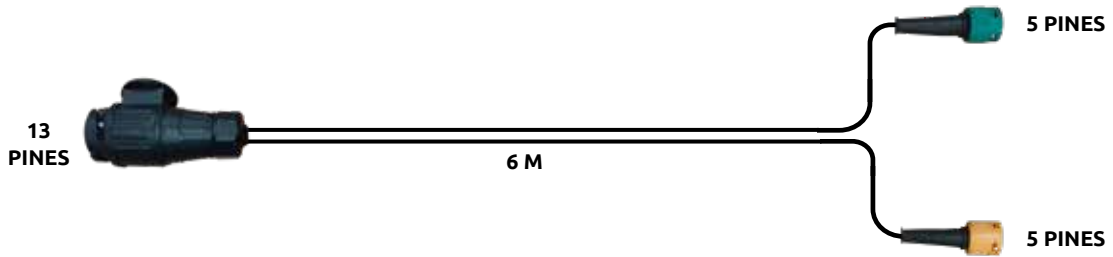

FA102704

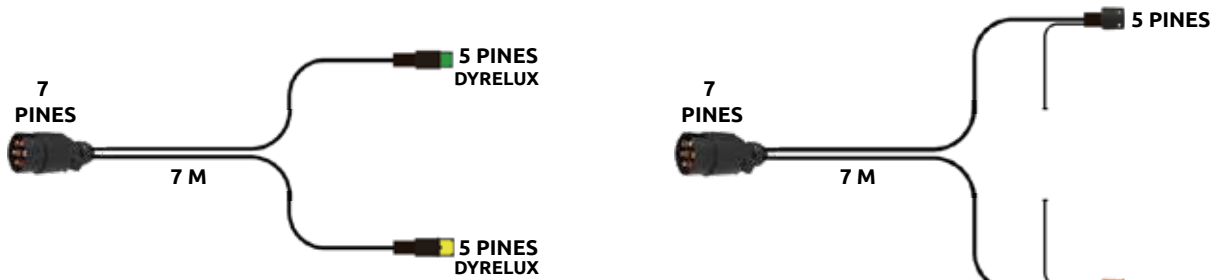

FA102700

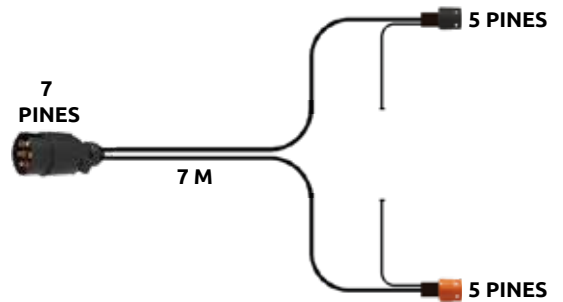

FA102701

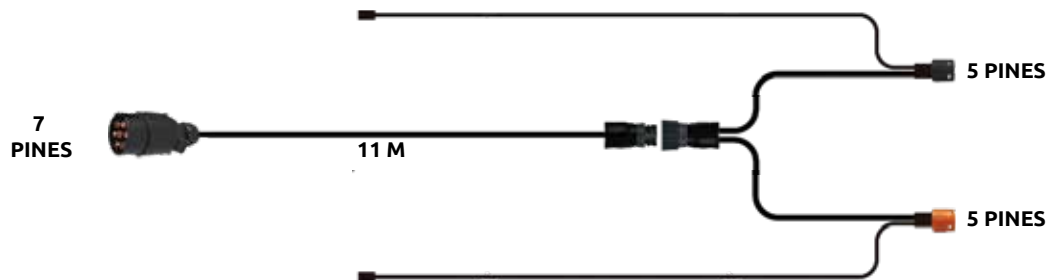

FA102702

ADAPTADORES 12V



FA200715

Adaptador 12 V
Clavija 7 polos Tipo N (ISO 1724)
a base 13 polos (ISO 11446)



FA200714

Adaptador alternativo 12 V
Clavija 7 polos Tipo N (ISO 1724)
a base 13 polos (ISO 11446)



FA200718

Adaptador compacto 12 V
Clavija 13 polos (ISO 11446)
a base 7 polos Tipo N (ISO 1724)



Señalización

Safety signs





VEHÍCULO AGRÍCOLA

Homologadas



Juego 2 placas

423 x 423 mm

FA101292

Aluminio | Homologación europea

Homologadas



Juego 2 placas

423 x 423 mm

FA101292-AD

Adhesiva | Homologación europea

Homologadas



Juego 2 placas

423 x 282 mm

FA101293

Aluminio | Homologación europea

Homologadas



Juego 2 placas

423 x 282 mm

FA101293-AD

Adhesiva | Homologación europea

Homologadas

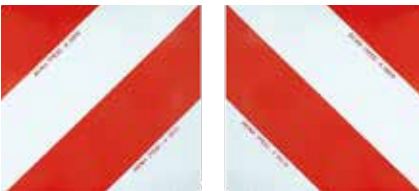

Juego 2 placas

282 x 282 mm

FA101208

Aluminio | Homologación europea

Homologadas



Juego 2 placas

282 x 282 mm

FA101208-AD

Adhesiva | Homologación europea

Homologadas



846 x 141 mm

FA101207-AD

Adhesiva | Homologación europea

Homologadas



Juego 2 placas

423 x 141 mm

FA101206-AD

Adhesiva | Homologación europea





EXTREMO CARGA



500 x 500 mm

FA101181 Aluminio | V-20

ABS



500 x 500 mm

FA101181-P Plástica | V-20



423 x 423 mm

FA101160 Izq.
Aluminio



423 x 423 mm

FA101161 Dch.
Aluminio



285 x 285 mm

FA101162 Izq.
Aluminio



285 x 285 mm

FA101163 Dch.
Aluminio

VEHÍCULO LARGO V-6

Placas Europeas ECE 70-00 / ECE 70-01



Juego 2 placas

565 x 197 mm

FA101171 Aluminio



Juego 2 placas

565 x 197 mm

FA101168 Adhesiva



1130 x 197 mm

FA101170 Aluminio



Juego 2 placas

565 x 197 mm

FA108288 Termoplástico



TRANSPORTE ESPECIAL

**CONVOI
AGRICOLE**

FA101288 1200 x 400 mm
Convoy agrícola



FA101261

Cartel avisador de acompañamiento de transporte especial magnético | **V-21**

**TRANSPORTE
DE
ANIMALES VIVOS**

280 x 200 mm

FA101290

Transporte de animales vivos



Con iluminación

FA101262

Cartel avisador de acompañamiento de transporte especial con iluminación, fijación con tornillos o tirantes vierteaguas | **V-21**

DISCOS LIMITACIÓN DE VELOCIDAD V-4

Ø 200 mm



FA108286-25



FA108286-30



FA108286-35



FA108286-40



FA108286-50



FA108286-60



FA108286-70



FA108286-80



FA108286-90



Ø 100 mm

FA108286-45

VEHÍCULO LENTO V-5



365 x 365 mm

FA101180 Aluminio

CINTAS REFLECTANTE V-23



3M

50 mm

● **FA101191-A3M**

○ **FA101191-B3M**

● **FA101191-R3M**

Rollo de 50 m.

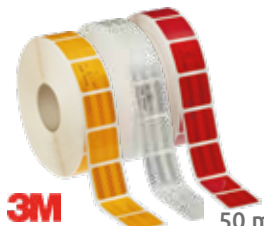

3M

50 mm

● **FA101191-A3ML**

○ **FA101191-B3ML**

● **FA101191-R3ML**

Rollo de 50 m.





faycom
www.faycom.es

FABRICACIÓN Y COMERCIALIZACIÓN DE SISTEMAS Y
SUS COMPONENTES DE ILUMINACIÓN, SEÑALIZACIÓN
Y SEGURIDAD, PARA TODO TIPO DE VEHICULO DE
SERVICIOS, INDUSTRIALES, AGRÍCOLAS Y
COMERCIALES, RECOGIENDO CADA UNA DE
SUS NECESIDADES.

NOS INSPIRAMOS EN TUS NECESIDADES
PARA ESTABLECER NUESTROS COMPROMISOS



faycom

Santo Domingo, 5 • Nave 9 • Polígono Centrovía

50198 • La Muela (Zaragoza)

+34 976 149 167

www.faycom.es

comercial@faycom.es